

GUARNIZIONI: VEDI PAGINA 95
SEALS: SEE PAGE 95
DICHTUNGEN: SIEHE SEITE 95

Codice Code Bestell-Nr.	ØAL	ØS	ØD	F	LF	L	L1	kg	Set guarnizioni Seal kits Dichtsätze
CGXX050040020	40	20	49	M44x1,5	19	40	32	0,28	GKGCXX040020
CGXX050040025	40	25	49	M44x1,5	19	40	32	0,23	GKGCXX040025
CGXX060050025	50	25	59	M54x1,5	22	43	35	0,46	GKGCXX050025
CGXX060050030	50	30	59	M54x1,5	22	43	35	0,39	GKGCXX050030
CGXX070060030	60	30	69	M64x1,5	27	50	40	0,80	GKGCXX060030
CGXX070060035	60	35	69	M64x1,5	27	50	40	0,70	GKGCXX060035
CGXX070060040	60	40	69	M64x1,5	27	50	40	0,60	GKGCXX060040
CGXX080070035	70	35	79	M74x1,5	27	50	40	1,06	GKGCXX070035
CGXX080070040	70	40	79	M74x1,5	27	50	40	0,94	GKGCXX070040
NEW! CGXX095080040	80	40	94	M85x2	33	60	50	1,90	GKGCXX080040

MATERIALE - MATERIAL: AISI 316 ACCIAIO INOSSIDABILE - STAINLESS STEEL - ROSTFREIEM STAHL

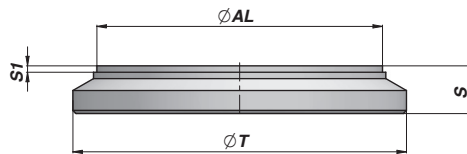
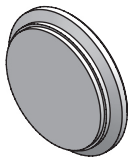

Codice Code Bestell-Nr.	ØAL	ØT	S	S1	kg
CFX00040050	40	50	10	2	0,13
CFX00050060	50	60	10	2	0,19
CFX00060070	60	70	12	2	0,33
CFX00070080	70	80	12	2	0,43
NEW! CFX00080095	80	95	12	2	0,60

MATERIALE - MATERIAL: AISI 316 ACCIAIO INOSSIDABILE - STAINLESS STEEL - ROSTFREIEM STAHL

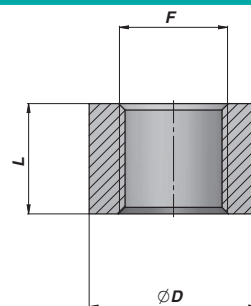
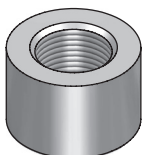

Codice Code Bestell-Nr.	F BSP	L	ØD	kg
CBSX040000	1/4"	15	20	3,00
CBSX060000	3/8"	17	26	4,00
NEW! CBSX080000	1/2"	20	32	4,00

MATERIALE - MATERIAL: AISI 316 ACCIAIO INOSSIDABILE - STAINLESS STEEL - ROSTFREIEM STAHL

FONDELLO IN INOX CON FORO ED ENTRATA OLIO
 STAINLESS STEEL END PLUG WITH CROSS HOLE AND INLET PORT
 ZYLINDERBODEN AUS ROSTFREIEM STAHL MIT BOHRUNG UND ÖLEINLASS

CFEX

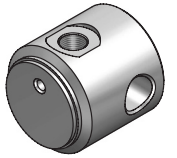
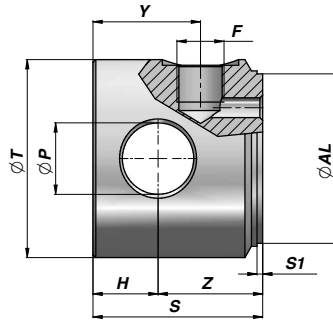

Codice Code Bestell-Nr.	ØAL	ØT	ØP	Z	H	F BSP	Y	S	S1	kg
CFEX040050416	40	50	16,20	35	15	1/4"	30	50	2	0,60
CFEX050060620	50	60	20,25	40	20	3/8"	38	60	2	1,10
CFEX060070625	60	70	25,25	37	23	3/8"	38	60	2	1,40
CFEX070080625	70	80	25,25	37	23	3/8"	38	60	2	1,95

MATERIALE - MATERIAL: AISI 316 ACCIAIO INOSSIDABILE - STAINLESS STEEL - ROSTFREIEM STAHL

BOCCOLA IN INOX
 STAINLESS STEEL BUSH
 BUCHSE AUS ROSTFREIEM STAHL

CBX

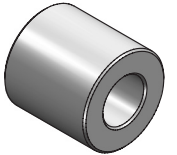
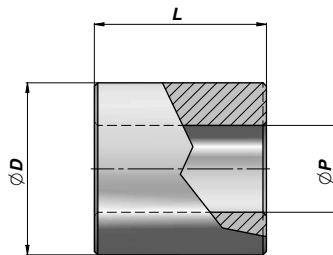

Codice Code Bestell-Nr.	ØP	ØD	L	kg
CBX016035030	16,20	35	30	0,18
CBX020040040	20,25	40	40	0,29
CBX025050050	25,25	50	50	0,56
CBX030060060	30,25	60	60	0,97

MATERIALE - MATERIAL: AISI 316 ACCIAIO INOSSIDABILE - STAINLESS STEEL - ROSTFREIEM STAHL

OCCHIO FISSO IN INOX
 STAINLESS STEEL MALE CLEVIS
 FESTAUGE AUS ROSTFREIEM STAHL

COFX

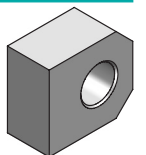
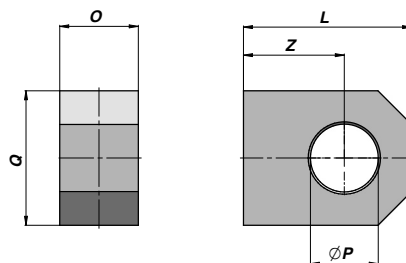

Codice Code Bestell-Nr.	ØP	Q	Z	L	kg
COFX0200000	20,25	25	45	30	0,35

MATERIALE - MATERIAL: AISI 316 ACCIAIO INOSSIDABILE - STAINLESS STEEL - ROSTFREIEM STAHL

CFFX

FORCELLA FILETTATA IN INOX
STAINLESS STEEL THREADED FORK
GABEL AUS ROSTFREIEM STAHL MIT GEWINDE

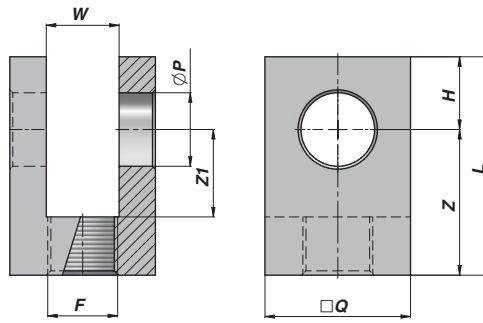
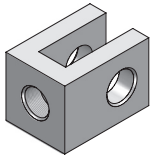

Codice Code Bestell-Nr.	ØP	L	Z	Z1	H	Q	W	F	kg
CFFX0161615	16,20	55	39	24	16	35	16	M16x1,5	0,30
CFFX0202015	20,25	65	45	30	20	40	20	M20x1,5	0,40
CFFX0252420	25,25	75	50	30	25	50	25	M24x2	0,75

MATERIALE - MATERIAL: AISI 316 ACCIAIO INOSSIDABILE - STAINLESS STEEL - ROSTFREIEM STAHL

CAGEX

NEW!

ANELLO A SALDARE IN INOX PER SNODO "GE TGR"
STAINLESS STEEL WELD-RING FOR "GE TGR" BALL-JOINT
SCHWEISSBARER RING AUS ROSTFREIEM STAHL FÜR GELENKLAGER "GE TGR"

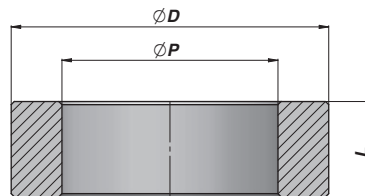

Codice Code Bestell-Nr.	Per For Für	ØD	L	ØP	kg
CAGEX050035	GE ø20	50	14	35	0,11
CAGEX069042	GE ø25	69	19	42	0,35
CAGEX075047	GE ø30	75	20	47	0,41
CAGEX094062	GE ø40	94	26	62	0,79

MATERIALE - MATERIAL: AISI 316 ACCIAIO INOSSIDABILE - STAINLESS STEEL - ROSTFREIEM STAHL

GE TGR

SNODO SFERICO RADIALE NON RICHIEDENTE MANUTENZIONE
MAINTENANCE FREE RADIAL BALL-JOINT
WARTUNGSFREIES RADIALGELENKLAGER

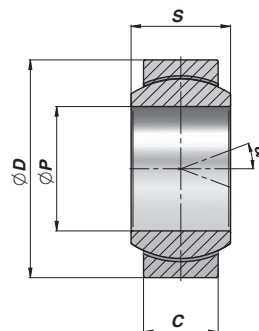

TYPE TGR

Codice Code Bestell-Nr. Type TGR	ØP	ØD	S	C	α	FC (kN)	kg
CGE0003603	20	35	16	12	9	41,5	0,06
CGE0003604	25	42	20	16	7	68	0,12
CGE0003605	30	47	22	18	6	88	0,16
CGE0003607	40	62	28	22	7	140	0,32

FC = CARICO DINAMICO AMMESSO - MAX DYNAMIC LOAD - MAX DYNAMISCHE LAST

ACCOPPIAMENTO - COUPLING - PAARUNG: CROMO DURO/PTFE - HARTCHROM/PTFE - CHROM/PTFE

MATERIALE - MATERIAL: AISI 316 ACCIAIO INOSSIDABILE - STAINLESS STEEL - ROSTFREIEM STAHL